

Assembly Instructions

Caution :You must read this before you proceed

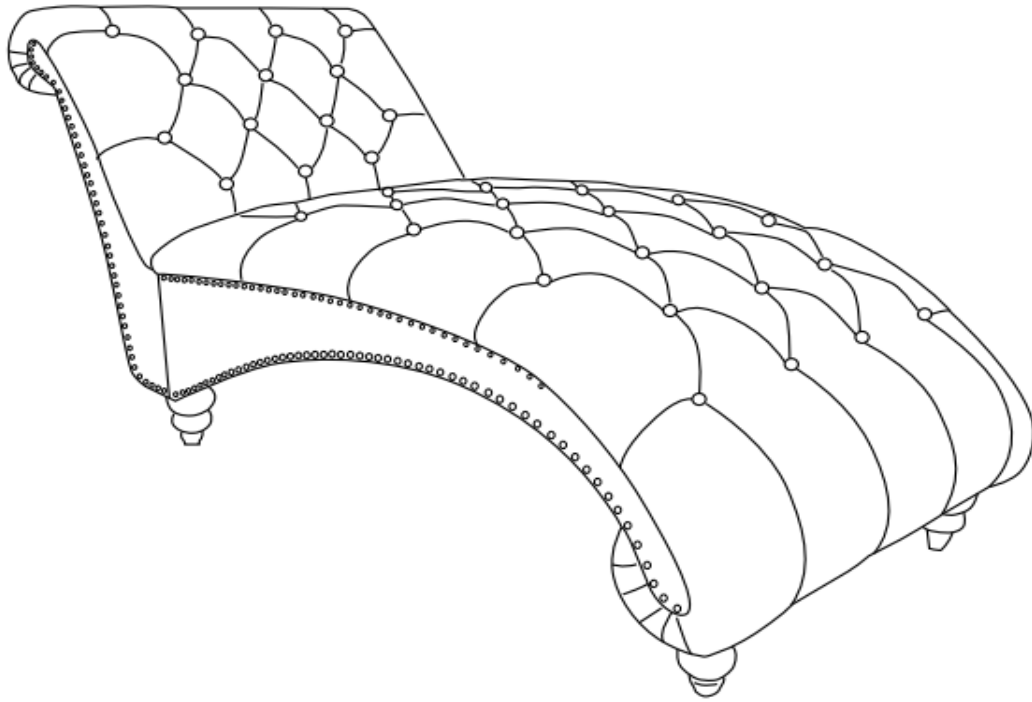



CHAISE



Parts List

Label	Picture	Description	QTY
A		Chaise Seat	1
B		Chaise Back	1
C		Leg	4

Hardware

Label	Picture	Description	QTY
①		Washer Ring	7
②		Bolt (M8*55MM)	5
③		Flat Washer	5
④		Spring Washer	5
⑤		Allen Wrench	1

Assembly Preparation

Before Beginning Assembly:

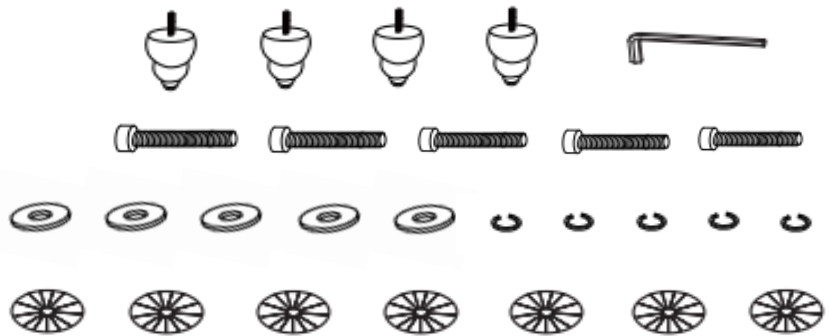
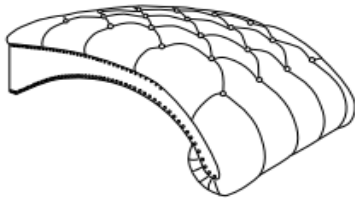
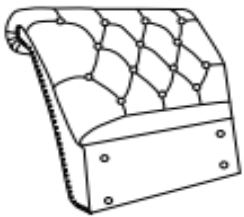

- Read instructions, cover to cover-



- Have 2 adults on hand for assembly-



- Do not assemble on flooring or carpet-



- Assemble on a clean non-marring surface (packing foam)-



- Save all packaging until finished-

Assembly Steps

OVERVIEW

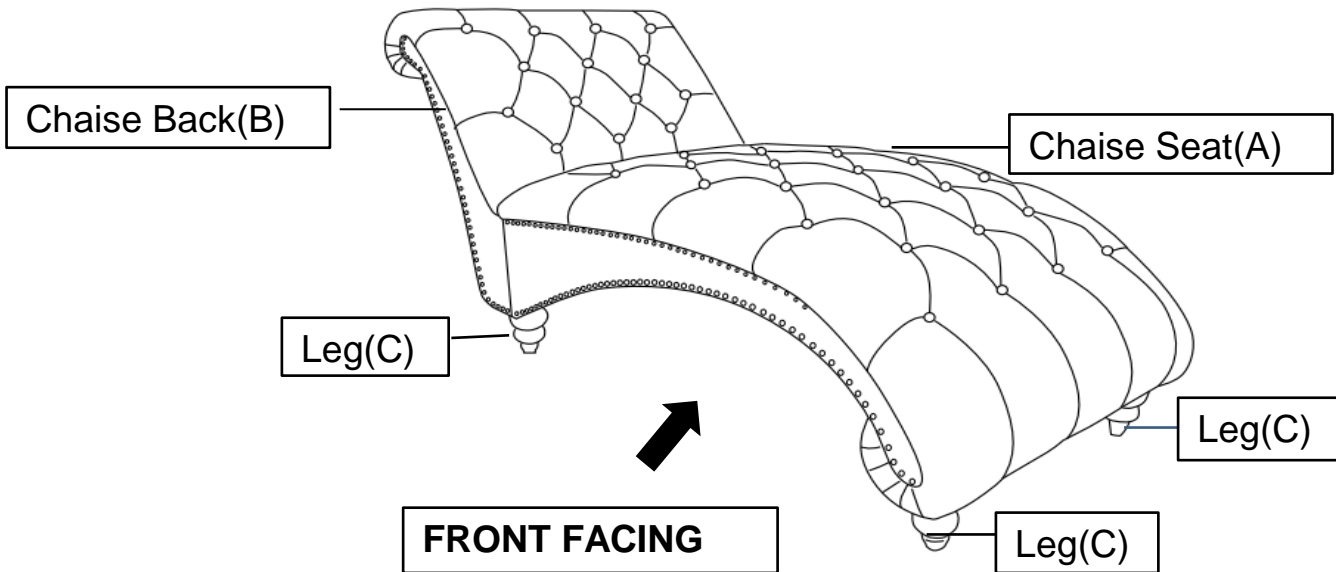

This Chaise has multiple parts and may require up to some 30 minutes to assemble. To give you an overview of the Chaise parts, the above picture is to help you put the various parts into perspective. Please read through the instructions below to familiarise yourself with the parts and steps before assembly.

Step 1

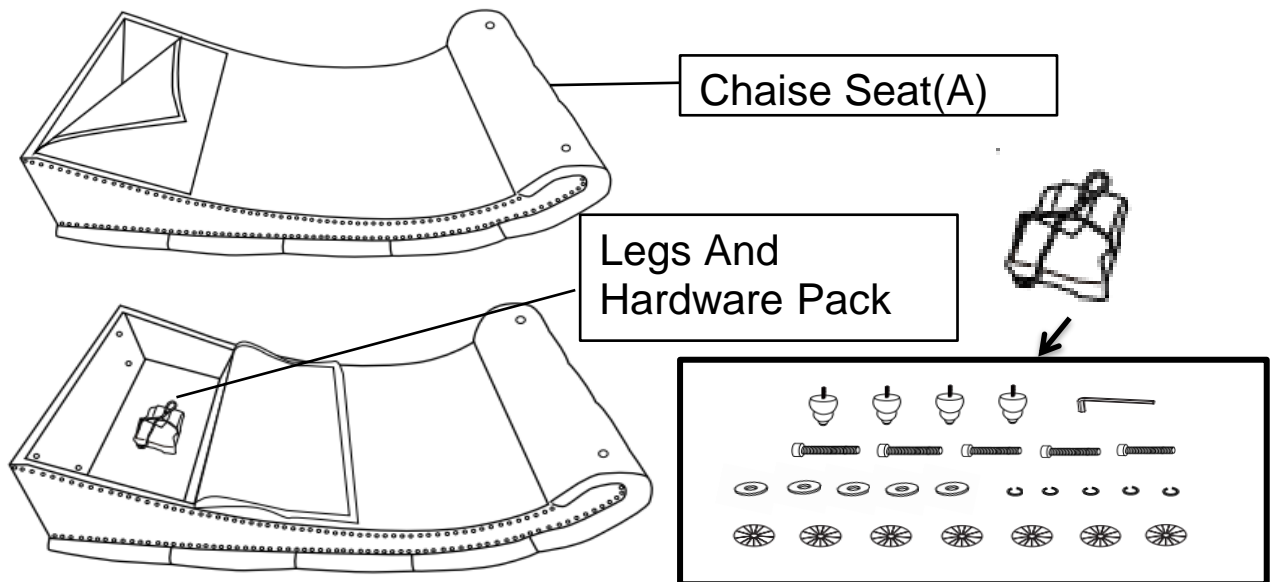

Position the Chaise Seat(A) facedown on a clean, non-marring surface, as shown.

Unzip to open pouch and remove the 4 legs(C) and the hardware pack, close the pouch.

Step 2

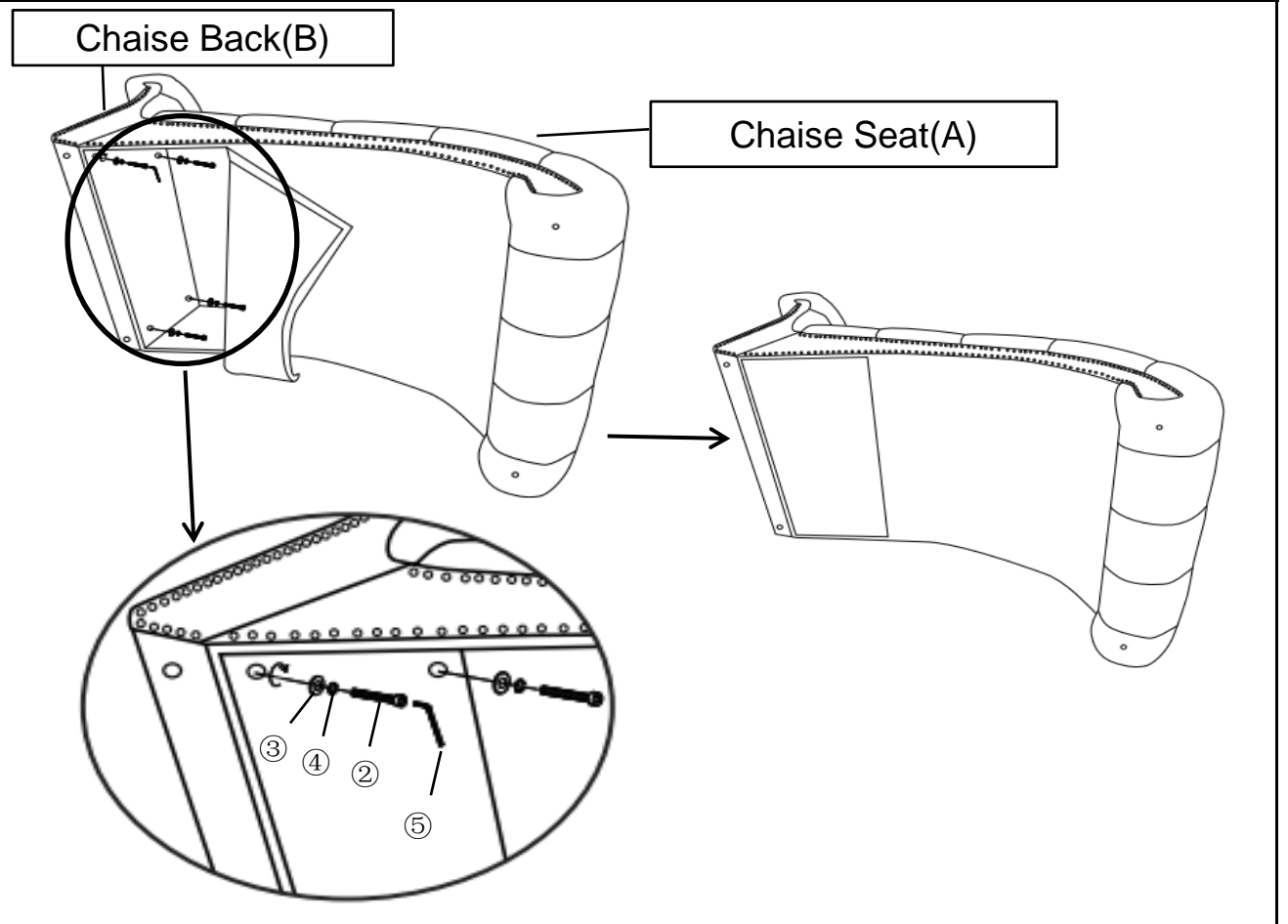

Install the Chaise Back(B) into the bottom of the Chaise Seat(A) using Bolt (2), Spring Washer(4), Flat Washer(3) with the Allen Wrench(5). Tighten all bolts at all joints completely.

Step 3

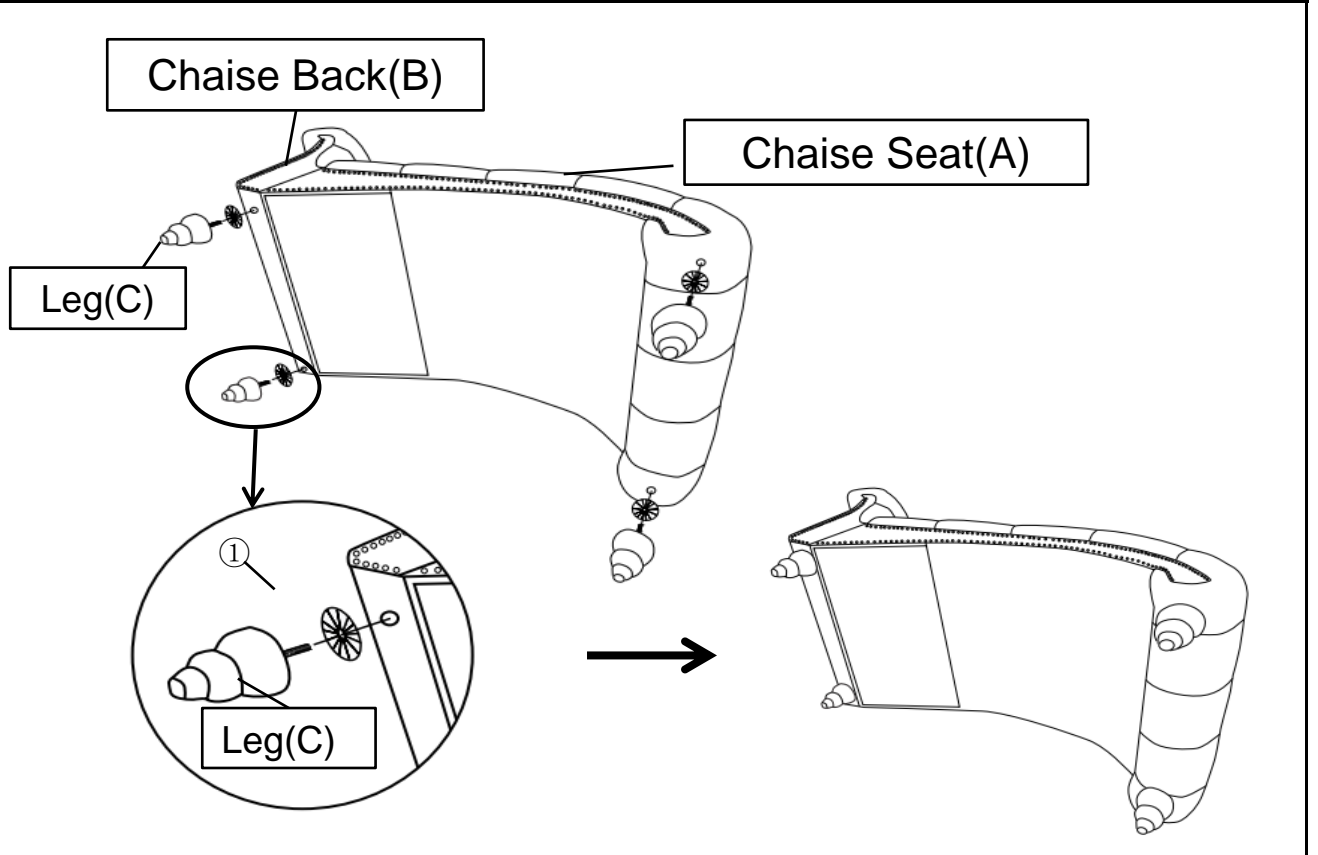

Install the Leg(C) onto the Chaise Seat(A) and the Chaise Back(B) by placing a Washer Ring(①) onto the stem. Insert the threaded stem into the threaded hole at each corner of the bottom of the Chaise Seat(A) and the Chaise Back(B). Tighten the Leg by turning clockwise, as shown. Repeat the same steps to install the remaining 3 legs.

Step 4

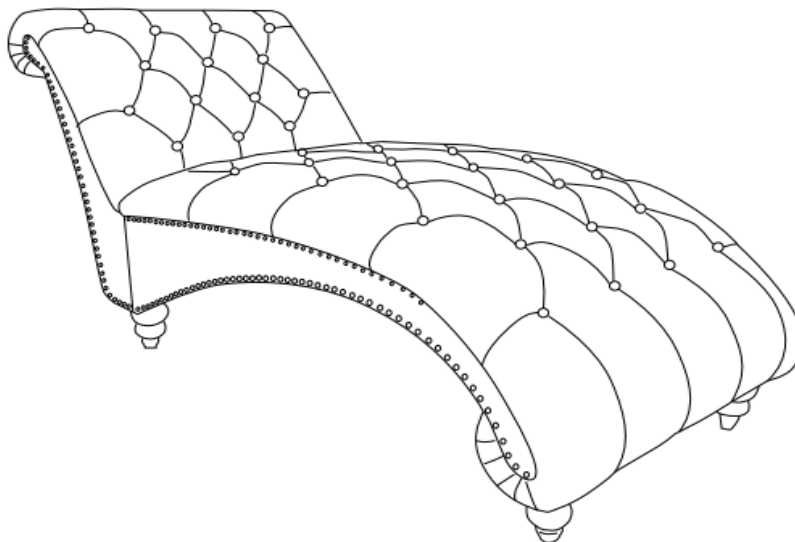

Add or remove Washer Ring(①) where needed to achieve stability.

Note:The use of Washer Ring(①) are optional and is especially useful to help alleviate slight wobbleness. Some Legs may need more than one Washer Ring(①) whilst some Legs may not need any.



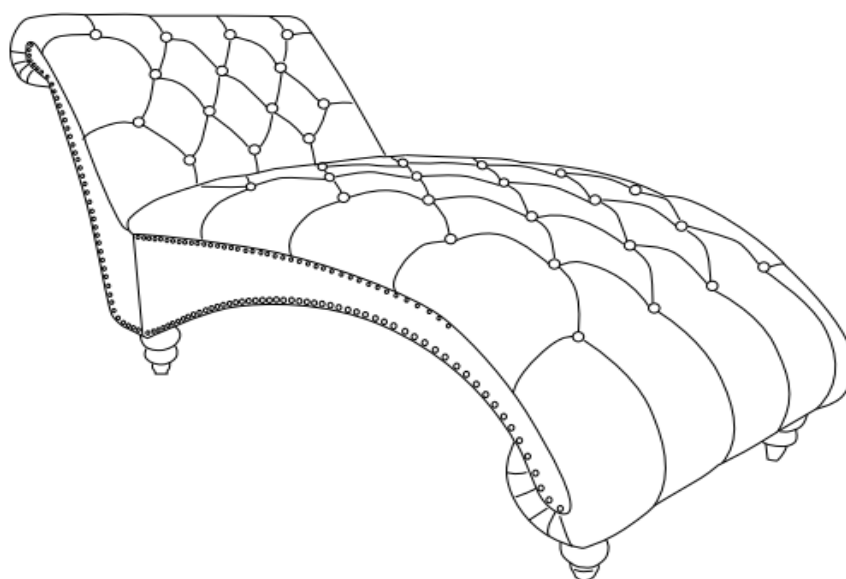







Step 5

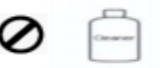

Your Chaise is ready for use.

Note:This Chaise can only be used on a flat, level surface.

Care & Maintenance

-  ● Furniture may scratch floors. We recommend using furniture pads to protect your floors.
 -  ● Do not put hot items directly on furniture surface.
 -  ● Do not clean furniture with harsh cleansers or polish.
 -  ● Do not place furniture under direct sunlight.
 -  ● Do not place furniture near heating or cooling vents.
 -  ● Do not write on furniture without a padded barrier to protect the surface.
 -  ● Do not place furniture outside . For indoor use only.
 -  ● Not for commercial use. For residential use only.
 -  ● Stains may be removed with mild soap solution and damp cloth.
 -  ● Children should not climb or jump on the furniture.
-
-  ● Dust and pick-up spills using a clean, non-colored, lint-free cloth.